

# Theoretical Analysis of VoIP Transmission Through Different Wireless Access Technologies

Emna CHARFI, Lamia CHAARI and Lotfi KAMOUN

National School Engineering of SFAX, Laboratory of Electronics and Information Technologies,  
University of SFAX, SFAX

## Abstract

One of the challenges in today's wireless networks is to provide appropriate throughput for data and multimedia application. The physical data rate enhancements can be achieved through new physical capabilities, however to achieve high efficiency and to improve the throughput at the medium access control (MAC) layer, new and innovative MAC mechanisms are required. The disgraceful overhead occurs at the MAC layer prevents the WLANs from achieving desirable performance, this problem becomes more severe in the very high-speed WLAN. We will consider the potential benefits of frame aggregation in order to enhance the throughput. In this paper, the latest MAC layer mechanisms of IEEE 802.11, IEEE 802.11e and 802.11n standards are explained in details. Besides a theoretical analysis is used to evaluate and analyze the theoretical capacity of VoIP over different emerging wireless access technologies, ranging from IEEE 802.11 to IEEE 802.11n. Results confirm our expectation.

**Keywords:** Access technologies, frame Aggregation, throughput enhancement, VoIP, WLAN.

## 1. Introduction

Recently, IEEE 802.11 WLAN has gained a widespread position in the market for wireless networking. The 802.11 standard defines both the medium access control (MAC) layer and the physical layer (PHY) specifications [1]. The mandatory part of the 802.11 MAC is called the Distributed Coordination Function (DCF), which is based on Carrier Sense Multiple Access with Collision Avoidance (CSMA/CA) and the optional one is the Contention Free Period (PCF). The Enhance the current 802.11 MAC to expand support for applications with Quality of Service requirements such as VOIP, and in the capabilities and efficiency of the protocol requires new concepts and solutions in MAC mechanisms most of them are focused on overhead reduction. The overhead comes primarily from packet preambles, acknowledgements, contention windows and various interframe-spacing parameters. Through the IEEE 802.11e[2] and the IEEE802.11n [3][4] amendments, new channel access

techniques have been introduced to enhance the throughput and to reduce the overhead. The most known techniques are:

Enhanced Distributed Coordination Access (EDCA)[5][6]: which is an extension of the basic DCF introduced in the 802.11e amendment to support prioritized quality of service.

Block Acknowledgement protocol (BA)[7][8][15], was introduced with the 802.11e amendment to improve efficiency by allowing for the transfer of a block of data frames that are acknowledged with a single Block Acknowledgement (BA) frame instead of an ACK for each data frame.

Reduced inter-frame space (RIFS) [8].

Frame aggregation at MAC Service Data Unit (MSDU)[4][9][10], the principle of MSDU aggregation is to allow multiple MSDUs to be sent to the same receiver concatenated in a single MPDU.

Frame aggregation at MAC Protocol Data Unit (MPDU) [10][11], the principle of MPDU aggregation is to join multiple MPDUs to be sent with a single PHY header.

All these enhancements improve 802.11e MAC efficiency while retaining the reliability, simplicity, interoperability and QoS support of 802.11/802.11e MAC.

Many others mechanisms have been suggested in the literature to enhance the capacity of wireless technologies.

In [12] the authors develop a new wireless link quality metric, ECOT that enables a high throughput route setup in wireless mesh networks. The key feature of ECOT is being applicable to diverse mesh network environments where IEEE 802.11 MAC (Medium Access Control) variants are used. They take into account the following features (EDCA with Block Acknowledgment and 802.11n A-MPDU Aggregation).

In [13] the authors propose an adaptive delayed channel access that outperforms the current 802.11n specification. They introduce an adaptive aggregate size threshold that gradually increases or decreases until the number of segments in the sender's buffer size of the TCP flow is reached.

In the literature there also some works that evaluates via simulations or analytical models the wireless access protocols efficiency.

In [14] the authors analyze the MAC protocols performance in imperfect wireless channel and develop an analytical model to evaluate the unsaturated throughput performance of the frame-burst-based CSMA/CA protocol. In this article we mainly focus on the application of IEEE802.11 WLAN mechanisms to real-time services such as VoIP. To conduct this study thoroughly, the theoretical capacity and the efficiency of the studied approach are computed related to the physical rate. This paper is organized as follows: In Section 2 the theoretical capacity of VoIP transmission through basic MAC protocols (CSMA/CA, PCF, RTS/CTS) that have been adopted in the IEEE 802.11a/b/g is analyzed. Section 3 deals with determining the performance for some extension concepts that have been introduced in the 802.11e amendment to support prioritized quality of service. We mainly focus on the EDCA and Immediate Block Acknowledgement with SIFS or RIFS mode. Section 4 concentrates on the latest work of MAC 802.11n enhancements. Frame aggregation methods that TGN has proposed in the latest 802.11n standard draft are evaluated for VoIP traffic. , and how these can improve WLANs throughput and maximize efficiency is discussed. For each section, we begin with a brief outline of the studied MAC concept, followed by a discussion of its maximal throughput limitations because of overhead. Section 6 concludes the paper by summarizing this article's findings.

## 2. Theoretical Capacity analysis of VoIP transmission through basic MAC protocols

### 2.1 Carrier Sense Multiple Access with Collision Avoidance: CSMA/CA (DCF)

The principle of the mechanism CSMA/CA is based on listening to the channel to see if it is occupied. The node must insure that the medium is free for a certain length (DIFS) before emitting. If the medium is idle and continues to be idle for a period of time set in DIFS, then the station gains access to the medium and can start sending the pending frame. However, if the medium become busy during the time the station is monitoring the medium, a random backoff procedure will start. A random backoff time is chosen in the interval  $[CW_{min}, CW_{max}]$  where,  $CW$  in the contention window. The timer will decrease the backoff time when the medium is idle. If the medium is busy during a station's backoff procedure, the backoff timer will be suspended. When many stations are competing for the medium, the station that chose the

shortest backoff time will gain access to the medium first. DCF uses positive acknowledgment. When a frame is successfully received by the destination station, an ACK frame is sent back to the source station after a SIFS period. The principle of the CSMA/CA mechanism is illustrated by fig.1.

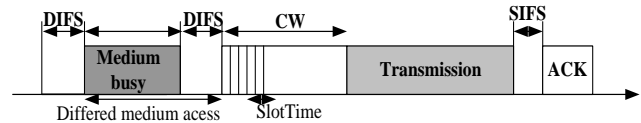

Fig. 1 CSMA/CA mechanism

In the continuation, we considered the scenario described by fig.2. The network comprises a single IEEE 802.11 basic service set (BSS) with one access point (AP), and a number of wireless users. Temporal multiplexing between  $N$  stations [16][17] is illustrated by fig.3.

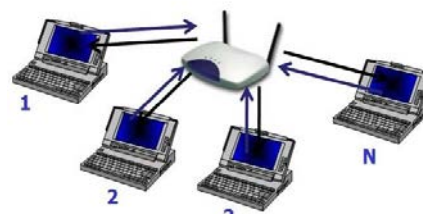

Fig. 2 Network topology

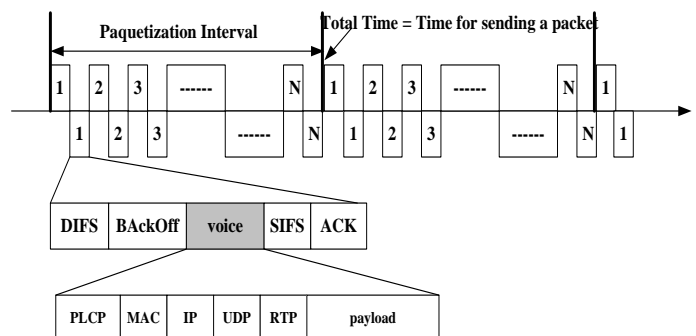

Fig.3 Temporal multiplexing

We focus on the capacity of the wireless network as the principal metric of interest. We define capacity in this context to be the maximum number of simultaneous, bidirectional calls that can be supported. Voice traffic is generated by packetizing the output of a voice encoder (we consider G.711, G.723 and G.729 schemes, without the use of silence suppression), creating packets each containing a fixed amount of voice data; we consider 20 ms, of voice data per packet.

In wireless networks, G.711 is applied for encoding telephone audio signal at a rate of 64 kbps with a sample rate of 8 kHz and 8 bits per sample. In an IP network, voice is converted into packets with durations of 5, 10 or

20 ms of sampled voice, and these samples are encapsulated in a VoIP packet. G.723.1 codec belongs to the Algebraic Code Excited Linear Prediction (ACELP) family of codec and has two bit rates associated with it: 5.3 kbps and 6.3 kbps. The coder operates on speech frames of 30 ms corresponding to 240 samples at a sampling rate of 8000 samples/s. G.729 codec belongs to the Code Excited Linear Prediction coding (CELP) model speech coders and uses Conjugate Structure - Algebraic Code Excited Linear Prediction (CS-ACELP). This coder was originally designed for wireless applications at fixed 8 kbit/s output rate. The coder works on a frame of 80 speech samples (10 ms). In [18] factors affecting QoS such as packet loss, jitter, throughput, and delay for various capacity networks are studied for several codec's.

VoIP packets are transmitted over the network using RTP over UDP/IP. We present an upper bound on the network capacity, by making certain assumptions about the performance of the network.

The number of calls given by Eq(1) is based on temporal multiplexing provided by fig.3.

$$N = \frac{Packet_{Interval}}{2T_{total}} \quad (1)$$

Where the total duration of one packet is equal to:

$$T_{total} = T_{DIFS} + T_{CW} + T_{SIFS} + T_{ACK} + T_{voice-pkt}$$

The duration necessary for transmission one voice packet is given by Eq.2.

$$T_{voice-pkt} = T_{PLCP} + \frac{L_{voice-pkt}}{Bit_{rate}} \quad (2)$$

$$L_{voice-pkt} = L_{MAC} + L_{IP} + L_{UDP} + L_{RTP} + L_{voice}$$

Thus, the total number of calls will be given by Eq.3:

$$N = \frac{Packet_{Interval}}{2(T_{PLCP} + T_{DIFS} + T_{CW} + T_{SIFS} + T_{ACK} + \frac{L_{voice-pkt}}{Bit_{rate}})} \quad (3)$$

Fig.4 shows the capacity of the wireless network (number of calls) for different voice encoder. Parameters used to compute the numbers of calls are regrouped in table1.

The performance of the G.711, G.723.1 and G.729 codec are shown in Fig4. With all codec, there is a saturation of the capacity of the capacity with physical rate. With G.711, going from 802.11b to 802.11g enhances the capacity from 10 VoIP calls to 14calls. For each voice frame, a RTP/UDP/IP header has to be added. The proportion of this overhead is particularly high for small data packets.

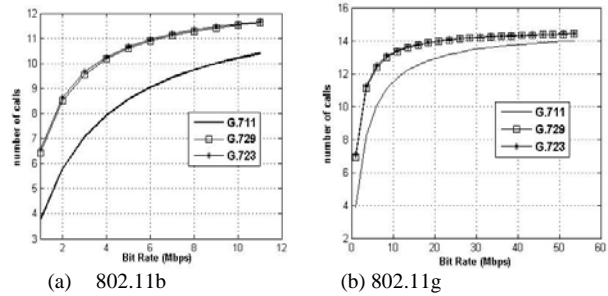

Fig.4 Number of call via bit rate 802.11b/g

## 2.2 RTS/CTS (Request To Send/ Clear To Send)

In order to eliminate hidden node problem, the IEEE802.11 MAC protocol defines an optional mechanism known as “Request To Send / Clear To Send” RTS/CTS. The node must insure that the medium is free for a certain length (DIFS) before emitting. If the medium is idle and continues to be idle this period, then the station gains access to the medium and can start sending the pending frame. Otherwise, the node enters in a backoff period, and after that, it transmits a short frame called RTS to reserve the channel. When the receiving node receives the RTS frame, it responds, after SIFS period with a clear to send (CTS) frame. The transmitting node is allowed to transmit only if the CTS frame is correctly received. Thus, the channel is reserved for the length of the transmission. When a frame is successfully received by the destination station, an ACK frame is sent back to the source station after a SIFS period.

As indicated in figure.5, RTS/CTS mechanism will change the timing diagram of successful data transmission and the VoIP capacity will be computed as below:

Table 1: Used Parameters

	Time (µs)	Length (Byte)
PLCP preamble	144.00	18
PLCP Header	48.00	6
PLCP	192.00	24
IP		20
UDP		8
RTP		12
Data voice	116.36	160 (G711), 20 (G729), 16 (G723)
ACK	10.18	14
Slot Time	9 (802.11g et n) 10 (802.11b)	
SIFS	16 (802.11g et n) 20 (802.11b)	
DIFS	34 (802.11g et n) 50 (802.11b)	
PIFS	25 (802.11g et n) 30 (802.11b)	

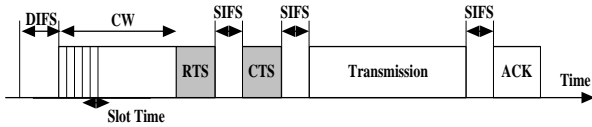

Fig.5 RTS/CTS mechanism

The total duration of one packet is equal to:

$$T_{total} = T_{DIFS} + T_{CW} + T_{RTS} + T_{CTS} + 3T_{SIFS} + T_{ACK} + T_{voice-pkt}$$

Thus, the total number of calls will be:

$$N = \frac{Packet_{Interval}}{2(T_{PLCP} + T_{DIFS} + T_{CW} + T_{RTS} + T_{CTS} + 3T_{SIFS} + T_{ACK} + \frac{L_{voice-pkt}}{Bit_{rate}})} \quad (3)$$

Fig.6 shows the capacity of the wireless network (number of calls) for different voice encoder when RTS/CTS mechanism is implemented.

The RTS/CTS handshake leads to more overhead. As can be seen by comparing figures 4a, 4b and figures 6a,6b, the VoIP capacity is better when CSMA/CA is used. CSMA/CA performs better than RTS/CTS since it uses less control frames.

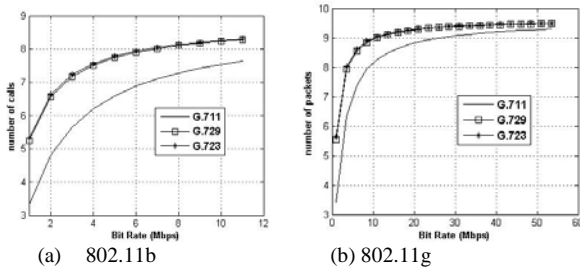

Fig.6 Number of call via bit rate 802.11b/g for RTS/CTS

### 2.3 Contention Free period: CFP

PCF mode may be an alternative way to convey real-time traffic over IEEE 802.11 WLANs. The idea is that by using a centralized controller, it is easier to realize QoS assurance in the central controller. With PCF, the point coordinator (PC), which resides in the AP, establishes a periodic contention free period (CFP) during which contention free access to the wireless medium is coordinated by the PC. The CFP period is initialized by the transmission of a Beacon frame. During the CFP the NAV of all nearby stations is set to the maximum expected duration of the CFP. In addition, all frame transfers during the CFP use an inter frame spacing that is less than that used to access the medium under DCF, preventing stations from gaining access to the medium using contention-based mechanisms. At the end of the CFP, the PC transmits a CF-End frame. The transmission in PCF period is shown by figure.7.

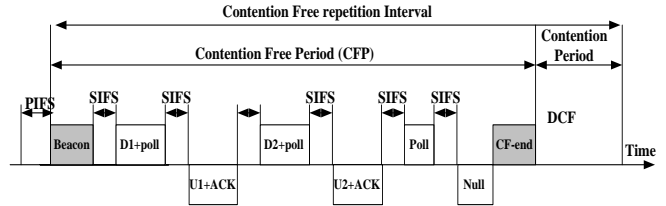

Fig.7 PCF mechanism

The total duration of transmission is given by:

$$T_{total} = T_{SIFS} + T_{voice-pkt} + T_{CFACK} + T_{CFPol}$$

Thus, the total number of calls will be:

$$N = \frac{T_{CFP} - T_{Beacon} - T_{SIFS} + T_{CFend} + T_{PIFS}}{2(T_{PLCP} + T_{SIFS} + \frac{L_{voice-pkt}}{Bit_{rate}} + T_{CFPoll} + T_{CFack})}$$

Parameters used to compute the numbers of calls in PCF mode are regrouped in table 2.

Table 2: PCF Parameters

Parameter	Length (Byte)
Beacon	40
data+CF-Poll,data+CF-ACK	28+Payload
CF-End,CF-End+CF-ACK	29

Fig.8 compares the capacity of the wireless network (802.11b, 802.11g) for different transmission mechanism (CSMA/CA, RTS/CTS and PCF) when G.711 voice encoder is used.

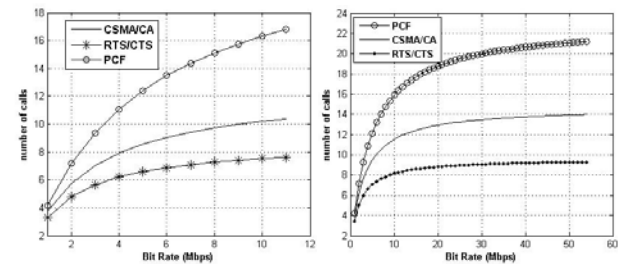

Fig.8 Number of call via bit rate 802.11b/g Access mechanisms

PCF achieves higher capacity than using DCF when polled stations have always packet to send. This can be credited to the higher overhead needs when using DCF such as performing Backoff before transmitting. Moreover PCF allows the uplink and downlink to use piggy-packed frames.

### 2.4 Throughput and efficiency analysis

The objective for this subsection is to see how overheads can affect the system throughput and system efficiency through a numerical analysis. For this analysis, Packet errors rate is

equal to 10%. The throughput “T” is given by equations 5, 6, 7 respectively for CSMA/CA, RTS/CTS and PCF modes:  
 For CSMA/CA, Eq(5)

$$T = \frac{\text{Payload} \cdot (1 - PER)}{(T_{PLCP} + T_{DIFS} + T_{CW} + T_{SIFS} + T_{ACK} + \frac{L_{voice-pkt}}{\text{Bit}_{rate}})} \quad (5)$$

For RTS/CTS, Eq(6)

$$T = \frac{\text{Payload} \cdot (1 - PER)}{(T_{PLCP} + T_{DIFS} + T_{CW} + T_{RTS} + T_{CTS} + 3T_{SIFS} + T_{ACK} + \frac{L_{voice-pkt}}{\text{Bit}_{rate}})} \quad (6)$$

For PCF, Eq(7)

$$T = \frac{\text{Payload} \cdot (1 - PER)}{(T_{PLCP} + T_{SIFS} + \frac{L_{voice-pkt}}{\text{Bit}_{rate}} + T_{CFPoll} + T_{CFack})} \quad (7)$$

Fig.9 compares the throughput of the wireless network (802.11b, 802.11g) for different transmission mechanism (CSMA/CA, RTS/CTS and PCF).

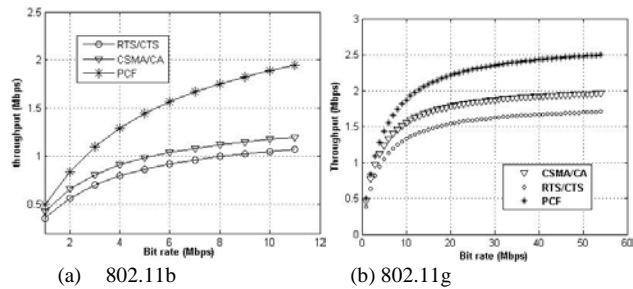

Fig.9 Throughput of 802.11b/g Access mechanisms

The throughput, for the two cases, is increasing when the physical rate increases. For IEEE802.11g, the throughput reaches more important values than these for IEEE802.11b. For example, at 11Mbps for IEEE802.11b, the throughput is equal to 1.1, 1.4, and 1.9 Mbps respectively for RTS/CTS, CSMA/CA, and PCF. While for IEEE802.11g, at 54Mbps physical rate, these values are equal to 1.7, 2, and 2.5Mbps for the previous mechanism.

The efficiency is given by Eq (8):

$$\eta = \frac{\text{Throughput}}{\text{Bit}_{rate}} \quad (8)$$

The efficiency, for the two standards, is represented by fig.10.a for 802.11b, and fig.10.b for 802.11g. It decreases when the physical rate increases. Since the throughput of PCF is the best one, then the efficiency is better for the Contention Free Period. The efficiency decreases immensely when the physical rate increases. Indeed, for IEEE802.11g, it was equal to 48% at 1Mbps

for CSMA/CA, and it decrease to 16% at 10Mbps, and it decrease again at 54Mbps and achieves 5%.

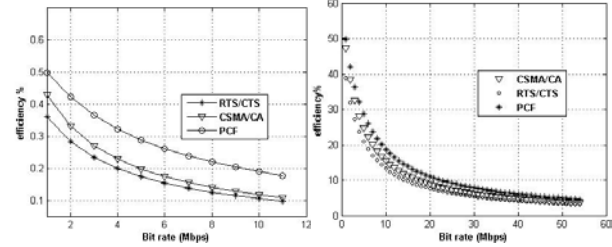

(a) 802.11b (b) 802.11g  
 Fig.10 Efficiency of 802.11b/g Access mechanisms

### 3. Theoretical Capacity analysis of VoIP transmission through Enhanced Distributed Channel Access

This scheme consists on grouping the frame and sharing the access time in the channel between several frames possessing the same destination. Thus, the frames are sent in a burst during the period of a transmit opportunity (TXOP). As defined by figure.11, each frame is acknowledged by an ACK frame, SIFS after the transmission of the data. In this scheme, a station is able to transmit after an AIFS period followed by a counter backoff if the medium is busy.

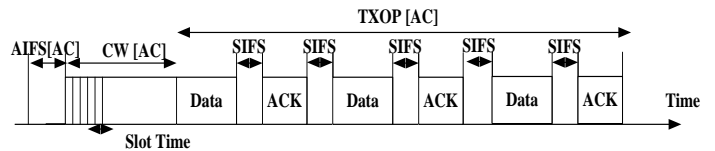

Fig.11 EDCA mechanism

The parameters of the types of data, voice and video are listed in table3.

Table 3: EDCA parameters

	CWmin	CWmax	AIFSN	TXOPLimit
voice	7	15	2	1.504(ms)
video	15	31	2	3.008(ms)

The total duration of one packet is equal to:

$$T_{total} = T_{AIFS} + T_{Backoff} + T_{ACK} + T_{SIFS} + T_{voicepkt}$$

The total number of calls is:

$$N = \frac{\text{Packet}_{Inetval}}{2(T_{PLCP} + T_{SIFS} + T_{CW} + T_{AIFS} + T_{ACK} + \frac{L_{voice-pkt}}{\text{Bit}_{rate}})}$$

The number of calls, fig.12, increases when the physical rate increases. It is more important for packets of voice,

than video packets. At 54Mbps, it is equal to 17 for voice packets while it is limited to 14 for video packets.

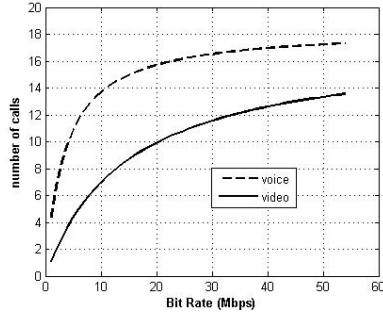

Fig.12 Number of calls for EDCA

The throughput is represented by fig.13, and it is equal to « T »:

$$T = \frac{\text{Payload} \cdot (1 - \text{PER})}{(T_{PLCP} + T_{AIFS} + T_{CW} + T_{SIFS} + T_{ACK} + \frac{L_{\text{voice-pkt}}}{\text{Bit}_{\text{rate}}})}$$

The throughput is greater when we are transmitting video packets. Indeed, the throughput reaches 5Mbps for video packet transmitted, and it is limited to 1Mbps for voice packet. When we want transmitting voice packets, it is more beneficial if we use the mechanism DCF then using EDCA.

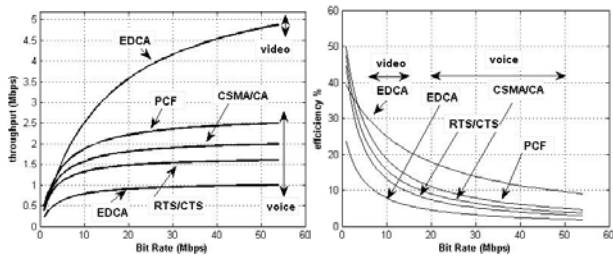

Fig.13 Throughput 802.11e

Fig.14 Efficiency 802.11e

Thus, the efficiency, which is presented by fig.14, is better when we are transmitting video packets. Similarly, the transmission of voice packets is more efficient by using the mechanism CSMA/CA, then proceeding to EDCA model. The problem here is that the efficiency decreases immensely when the physical rate increases. Indeed, for the transmission of voice packets using the EDCA mode, the efficiency is equal to 25% at 1Mbps and is decreased to 5% at 20Mbps, and 2% at 54Mbps.

#### 4. Theoretical Capacity analysis of VoIP transmission through Enhanced Distributed Channel Access

This scheme consists on grouping the frame and sharing the access time in the channel between several frames possessing the same destination. Thus, the frames are sent

in a burst, separated with SIFS, during the period of a transmit opportunity (TXOP). All the frames sent are acknowledged by a unique Block Acknowledgement (BA) instead of an ACK frame for each frame transmitted, as it is presented by fig.15.

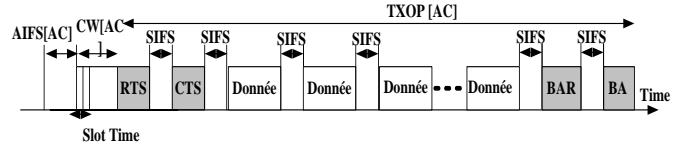

Fig.15 Immediate BA principle

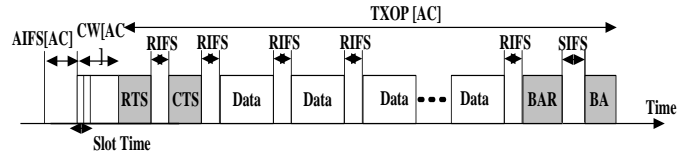

Fig.16 Immediate BA with Reduced Interface RIFS

The station transmits a request for BA (BAR), and the receiver respond with BA after a SIFS period. The transmission takes place during a TXOP period. The Immediate BA with RIFS mode is similar to Immediate BA SIFS mode, but the frames are separated with RIFS which is less than SIFS, as it is shown by fig.16. The total duration for transmission of one packet is:

$$T_{total} = T_{AIFS} + T_{CW} + T_{RTS} + T_{CTS} + 3T_{SIFS} + a * (T_{\text{voicepkt}} + T_{SIFS}) + T_{BAR} + T_{BA}$$

Where “a” is the number of packet per TXOP period, which is defined as:

$$TXOP_{Limit} = T_{RTS} + T_{CTS} + 3T_{SIFS} + a * (T_{\text{voicepkt}} + T_{SIFS}) + T_{BAR} + T_{BA}$$

Thus “a” is :

$$a = \frac{TXOP_{Limit} - T_{RTS} - T_{CTS} - 3T_{SIFS} - T_{BAR} - T_{BA}}{(T_{PLCP} + T_{SIFS} + \frac{L_{\text{voice-pkt}}}{\text{Bit}_{\text{rate}}})}$$

The number of video packets per TXOP is shown by fig.17, and it is more important than voice packets for the two model IBA SIFS mode or IBA RIFS mode.

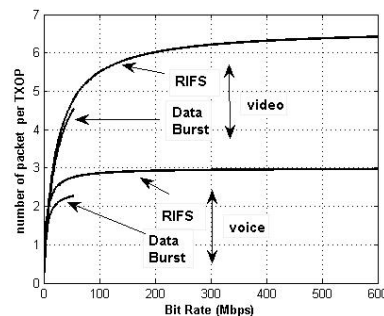

Fig.17 Number of packets per TXOP

Since the introduction of the RIFS mode is appeared with IEEE802.11n, the physical rate is spread to 540Mbps (Very High Throughput). For the mode RIFS, the number of packets per TXOP is better than the SIFS mode, and continues to increase and keeps a constant values at VHT. For Block Acknowledgement using RIFS, we replace

$$\frac{L_{voice-pkt}}{Bit_{rate}} + T_{SIFS} \quad \text{by} \quad \frac{L_{voice-pkt}}{Bit_{rate}} + T_{RIFS}$$

Let A denote the total number of packets for all N stations:  $A = N * a$ , Where N is the number of stations, and it is equal to:  $N = \frac{Packet_{Interval}}{2T_{total}}$

Since  $T_{total}$  has a fixed value, N is a constant number.

$$T_{total} = T_{AIFS} + T_{CW} + TXOP_{limit}$$

The total number of packets, as shown by fig.18, is more important when using the IBA mode RIFS, but at VHT, and when we use reduce inter frame space, the total number of packet increase and is nearly equal for voice and video parquets.

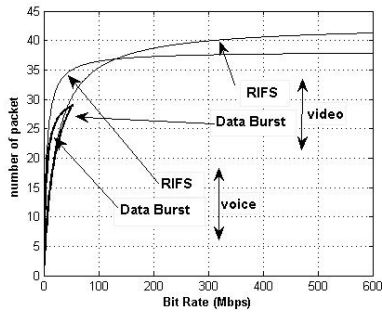

Fig.18 Total number of packets

The throughput is defined by:

$$T = \frac{Payload * a * (1 - PER)}{[T_{AIFS} + T_{CW} + 3T_{SIFS} + T_{RTS} + T_{CTS} + T_{BAR} + T_{BA} + T_{ACK} + a \left( T_{PLCP} + \frac{L_{VOICEpkt}}{Bit_{rate}} + T_{Sifs} \right)]}$$

Fig.19 and fig.20 represent the throughput and the efficiency of voice and video respectively. The throughput is more important by using the RIFS mode than the SIFS mode especially at Very High Throughput. It increases as the number of packets per TXOP increases. The efficiency presents the same limitation as previously. It decreases immensely, and it is near to zero, by increasing the physical rate.

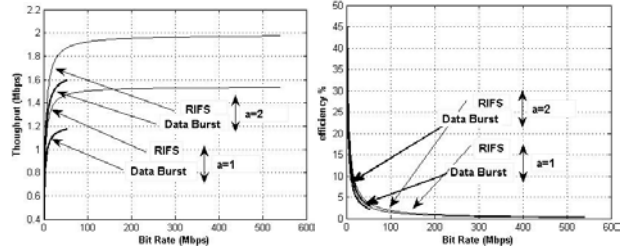

Fig.19 Throughput and efficiency for voice packets

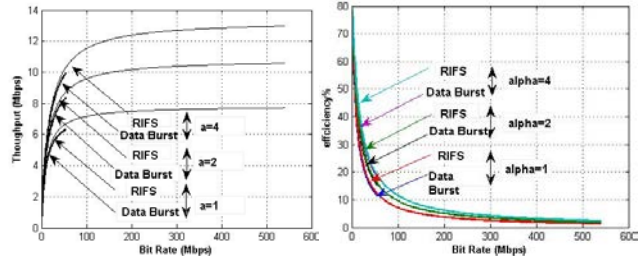

Fig.20 Throughput and efficiency for video packets

### 5. Theoretical Capacity analysis of VoIP transmission through Aggregation mechanism

The standard High Throughput IEEE 802.11n adapts two approaches for the aggregation data. The first one is the Aggregated MAC Service Data Unit (A-MSDU), and the second is Aggregated MAC Protocol Data Unit (A-MPDU). The transmission of aggregated data is shown by fig.21.

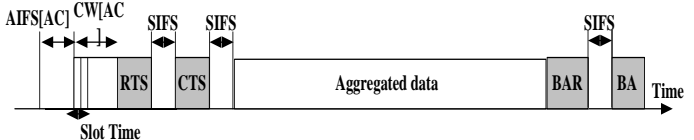

Fig.21 Transmission of aggregated data

#### 5.1 A-MSDU

With A-MSDU, MAC service data units (MSDUs) received from the LLC and destined for the same receiver and of the same service category (same traffic identifier or TID) may be accumulated and encapsulated in a single MAC protocol data unit (MPDU).

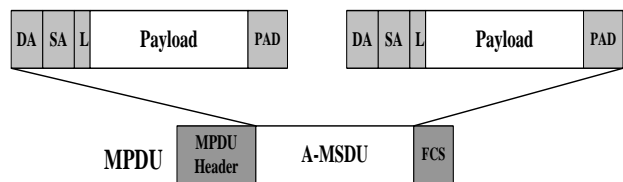

Fig.22 A-MSDU data

As shown by [fig.22](#), the MSDU as received from the LLC is prefixed with a 14 byte subframe header consisting of the destination address (DA), source address (SA), and a length field giving the length of the SDU in bytes. The header together with the SDU is padded with 0 to 3 bytes to round the subframe to a 32-bit word boundary. Multiple such subframes may be concatenated together to form the payload of the QoS Data frame, provided the total length of the data frame does not exceed the maximum MPDU size. The maximum length A-MSDU that a station can receive is either 3839 bytes or 7963 bytes. The total Duration of transmission is:

$$T_{total} = T_{AIFS} + T_{CW} + T_{RTS} + T_{CTS} + 3T_{SIFS} + T_{MPDU-hdr} + \theta T_{A-MSDU} + T_{BAR} + T_{BA}$$

Where  $\theta$  is the number of packet MSDU per station, and it is dependent with the length of one A-MSDU:

- For  $L_{A-MSDU}(\max_1) = 7963 \Rightarrow \theta = 31$
- For  $L_{A-MSDU}(\max_2) = 3839 \Rightarrow \theta = 15$

The time for sending one A-MSDU is:

$$T_{A-MSDU} = \frac{L_{DA} + L_{SA} + L_{length} + L_{MSDU} + L_{FCS} + L_{PAD}}{Bit\ rate}$$

And the length of one MSDU frame is defined by:

$$L_{MSDU} = L_{MAC} + L_{IP} + L_{UDP} + L_{RTP} + L_{voice}$$

Let A is the total number of packets for all the stations:

$$A = N * \theta \quad \text{Thus A will be: } A = \frac{Packet\ Interval}{2T_{total}} \theta$$

The total number of packet represented by [fig.23](#) is more important for voice packets. When the number of packets per MPDU increases, the throughput increases in the same way. Indeed, for voice packets, at 500Mbps physical rate, the total number of packet achieved for  $L_{A-MSDU}(\max_1)$  is more than 400, where it is equal to 220 for  $L_{A-MSDU}(\max_2)$ . The throughput T is given by:

$$T = \frac{Payload * \theta * (1 - PER)}{[T_{FLCP} + T_{AIFS} + T_{backoff} + 3 * T_{SIFS} + T_{RTS} + T_{CTS} + T_{BAR} + T_{BA} + T_{ACK} + \alpha * (\frac{L_{A-MSDU}}{Bit\ rate})]}$$

The throughput is shown by [fig.24](#), and it is more important for video packets than voice packets. It increases when we increase the size of MPDU frame. Similarly, the transmission of video packets is more efficient than voice packets. As shown by [fig.25](#), the efficiency in this mode of

transmission looks more important, indeed, the efficiency for packets voice for example doesn't fall many as the previous cases. It is equal to 80% at 1Mbps, and it will be 38% for the largest video MPDU size.

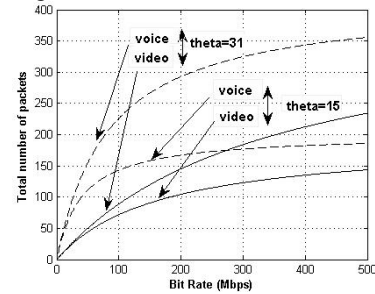

Fig.23 Total number of transmitted packets

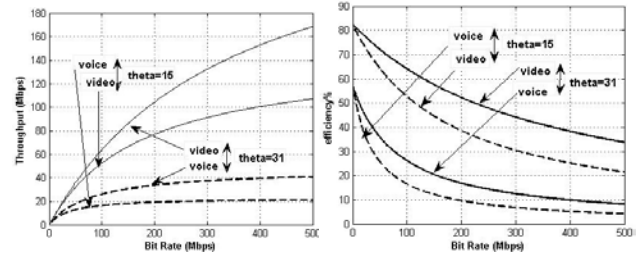

Fig.24 Throughput of A-MSDU Fig.25 Efficiency of A-MSDU

## 5.2 A-MPDU

With A-MPDU, is fully formed MAC PDUs are logically aggregated at the bottom of the MAC. A short MPDU delimiter is pretended to each MPDU and the aggregate presented to the PHY as the PSDU for transmission in a single PPDU. [Fig.26](#) shows the format of an A-MPDU.

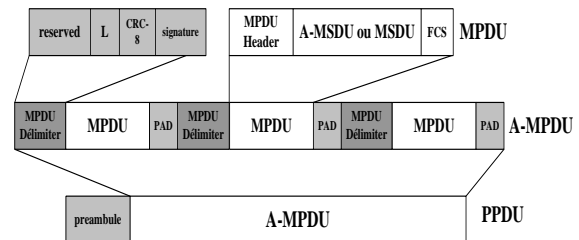

Fig.26 A-MPDU data

The MPDU delimiter is 32 bits in length and consists of a 4-bit reserved field, a 12-bit MPDU length field, an 8-bit CRC field, and an 8-bit signature field. The 8-bit CRC covers the 4-bit reserved and 12-bit length fields and validates the integrity of the header. The MPDU is padded with 0-3 bytes to round it up to a 32-bit word boundary. A station advertises the maximum A-MPDU length that it can receive in its HT Capabilities element. The advertised maximum length may be one of the following: 8191, 16383, 32767, or 65 535 bytes. The sending station must



not send an A-MPDU of greater length. The total Duration of transmission is:

$$T_{total} = T_{AIFS} + T_{CW} + T_{RTS} + T_{CTS} + 3T_{SIFS} + T_{preamble} + \xi T_{A-MPDU} + T_{BAR} + T_{BA}$$

Where  $\xi$  is the number of packet A- MPDU per station and it is dependent with the length of one A-MPDU:

$$T_{A-MPDU} = \frac{L_{MPDU-De\ limiter} + \theta L_{A-MSDU} + L_{PAD}}{Bit\ rate}$$

Where:

$$L_{A-MSDU} = L_{DA} + L_{SA} + L_{length} + L_{MSDU} + L_{PAD}$$

$$L_{MSDU} = L_{MAC} + L_{IP} + L_{UDP} + L_{RTP} + L_{voice}$$

Thus, the number of packet per MPDU is given by the following  $\varepsilon$  combination:

$$L_{A-MPDU}(\max_1) = 32767 \Rightarrow (\theta, \xi) = (15,8) \text{ or } (31,4)$$

$$L_{A-MPDU}(\max_2) = 16383 \Rightarrow (\theta, \xi) = (15,4) \text{ or } (31,2)$$

$$L_{A-MPDU}(\max_3) = 8191 \Rightarrow (\theta, \xi) = (15,2) \text{ or } (31,1)$$

Let B is the total number of packets for all the stations:

$$B = N * \theta * \xi$$

The total number of packets for voice and video data is shown by [fig.27](#) and [fig.28](#) respectively. The total number of packets for voice is more than video packets. It increases when we use the larger frame PPDU. Indeed, for the largest size of PPDU frame, the total number of voice packets is equal to 1180 at 500Mbps while it is equal to 450 for video packets. The throughput is :

$$T = \frac{\text{payload} * \theta * \varepsilon * 0.9}{[T_{PLCP} + T_{AIFS} + T_{Backoff} + 3 * T_{SIFS} + T_{RTS} + T_{CTS} + T_{BAR} + T_{BA} + T_{ACK} + \varepsilon * (\frac{L_{A-MPDU}}{Bit\ rate})]}$$

Where:

$$L_{A-MPDU} = L_{MPDU-de\ limiter} + \theta L_{A-MSDU} + L_{PAD}$$

As shown in [fig.29](#), the throughput is more important for video packets than voice packets. It increases immensely when the physical rate increases.

The efficiency is represented by [fig.30](#). As similarly, it is more important for video packets. It decrease when the physical rate increase, but it still efficient for Very High Throughput. For example, for voice packets, it is between 55% at 1Mbps and 35% at 500Mbps for the largest size of PPDU.

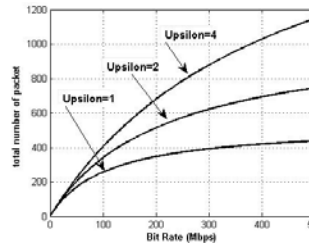

Fig.27 Number of calls (voice)

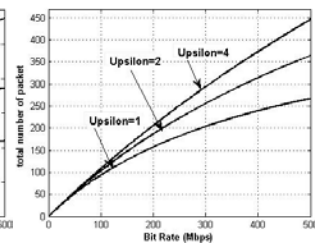

Fig.28 Number of calls (video)

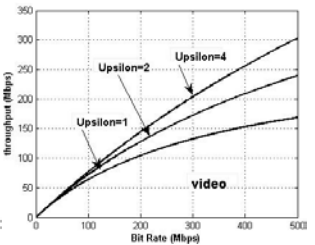
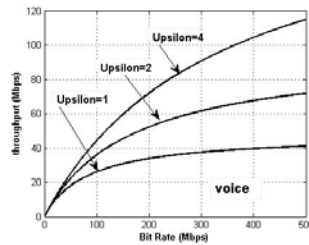

Fig.29 Throughput of A-MPDU data

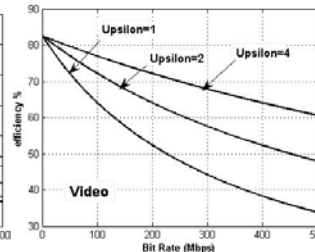
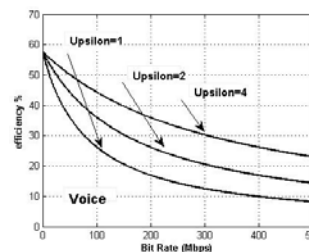

Fig.30 Efficiency of A-MPDU data

## 6. Conclusions

For legacy IEEE802.11, the problem of the access methods resides on the immense decrease of the efficiency for High throughput. The second amelioration was for supporting QoS, by introducing EDCA, Immediate Block Acknowledgment, but these mechanisms have the same limitation of efficiency. The most recently mechanism was introduced to Very High Throughput. The use of aggregation seems the most efficient. Indeed, the efficiency is maintained at a good level at VHT.

## References

- [1] IEEE, Part 11: Wireless LAN Medium Access Control (MAC) and Physical Layer (PHY) specifications, IEEE Std 802.11-1999, 1999.
- [2] IEEE, Part 11: Wireless LAN Medium Access Control (MAC) and Physical Layer (PHY) specifications Amendment 8: Medium Access Control (MAC) Quality of Service Enhancements, November 2005.
- [3] IEEE P802.11n™/D11.0 raft STANDARD for Information Technology, IEEE Part 11: Wireless LAN Medium Access Control (MAC) and Physical Layer (PHY) specifications Amendment 5: Enhancements for Higher Throughput, 2009 .

- [4] E.Perahia, R.Stacey, Next Generation Wireless LANs Throughput, robustness, and reliability in 802.11n, Cambridge University Press 2008,
- [5] Y. GE, H. Jennifer, C. Sunghyun, "An analytic study of tuning systems parameters in IEEE 802.11e enhanced distributed channel access", Computer networks journal, vol. 51, no8, 2007.
- [6] I. Inan, F. Keceli, E. Ayanoglu, "Analysis of the 802.11e Enhanced distributed channel access Function", technical report
- [7] Tinnirello, I. S. Choi, "Efficiency analysis of burst transmissions with block ACK in contention-based 802.11e WLANs", in ICC, 2005 5 ,pp 3455 - 3460
- [8] R. Roy , Y. Chen, S. Emeott, "Performance Analysis of data Agregation Techniques for wireless LAN", IEEE Globecom, 2006.
- [9] D. Skordoulis, Q. Ni, U. Ali, H. Marios "Analysis of Concatenation and Packing Mechanisms in IEEE 802.11n", PGNET 2007, Liverpool, UK, June 2007.
- [10] Y. Lin, W.S. Wong "Frame Aggregation and Optimal Frame Size Adaptation for IEEE 802.11n WLANs", Proc. IEEE GLOBECOM-2006, pp. 1-6
- [11] D Skordoulis, N. Qiang, H. Chen, A.P. DRIAN, P. TEPHENS, L. CHANGWEN, ABBES JAMALIPOUR "IEEE 802.11 n MAC frame aggregation mechanisms for next-generation", IEEE Wireless Communications, February 2008
- [12] S. Kim, O. Lee, S. Choi, Sung-Ju Lee, "MAC-Aware Routing Metric for 802.11 Wireless Mesh Networks", IEEE PIMRC 2009, September 2009.
- [13] D. Skordoulis, N. Qiang, G. Min, K. Borg, " Adaptive Delayed Channel Access for IEEE 802.11n WLANs", IEEE international conference on circuits and systems for communications, 26-28 may 2008.
- [14] Y. ZHENG, K. LU, W. Dapeng, F. Yuguang, "Performance Analysis Of Frame-Burst-based Medium Access Control Protocols Under Imperfect Wireless Channels", International journal of intelligent control and systems, (2005) VOL. 10, NO. 1, 2005, 43-51
- [15] L. Tianji, N. Qiang, Y. Xiao, "Investigation of the block ACK scheme in wireless ad hoc networks": Research Articles Wireless Communications & Mobile Computing Volume 6 , Issue 6 (2006) pp 877 - 888
- [16] W. Wang, C. Soung Liew, V.O.K. Li, "Solutions to Performance Problems in VoIP over 802.11 Wireless LAN", Vehicular Technology, IEEE Transactions on, v (54), issue 1, pp 366-384
- [17] P. David Hole, A. Fouad Tobagi "Capacity of an IEEE 802.11b Wireless LAN supporting VoIP", Conference on Communications (ICC) 2004
- [18] A. Mohd, O.L. loon, "performance of voice over ip (voip) over a wireless lan (wlan) for different audio/voice codecs", *Journal Teknologi*, 47(D) Dis. 2007: 39–60

**First Author** Emna CHARFI was born in Monastir, Tunisia, in 1985. She received her degree in Electrical Engineering and her Masters in Electronic Engineering from Sfax National School of Engineering (ENIS), Tunisia, in 2009 and 2010, respectively. In 2010, she joined the Sfax High Institute of Electronics and Communication, Tunisia, as an assistant. She is a member of Sfax Laboratory of Electronics and Information Technology. Her current research interests are communications, networking and are specially related to wireless local area network.

**Second Author** Dr Lamia CHAARI was born in Sfax, Tunisia, in 1972. She received the engineering and PhD degrees in electrical and electronic engineering from Sfax national engineering school (ENIS) in TUNISIA. Actually she is an associate professor in multimedia and informatics higher institute in SFAX She is also a researcher in electronic and technology information laboratory (LETI). Her scope of research are communications, networking and signal processing which are specially related to wireless and new generation networks.

**Third Author** Pr Lotfi Kamoun was born in Sfax Tunisia, 25 January. 1957. He received the electrical engineering degree from the Sciences and Techniques Faculty in Tunisia. Actually he is a Professor in Sfax national engineering school (ENIS) in TUNISIA. He is the director of electronic and technology information laboratory (LETI). His scope of research are communications, networking, Software radio and signal processing which are specially related to wireless and new generation networks.